

# C-SERIES C6,000-C8,000

The multi-directional forklift designed for the safe, space saving and productive handling of long and bulky loads.

# COMBILIFT

LIFTING INNOVATION



# C-SERIES

## C6000-C8000

### FRONTAL MODE

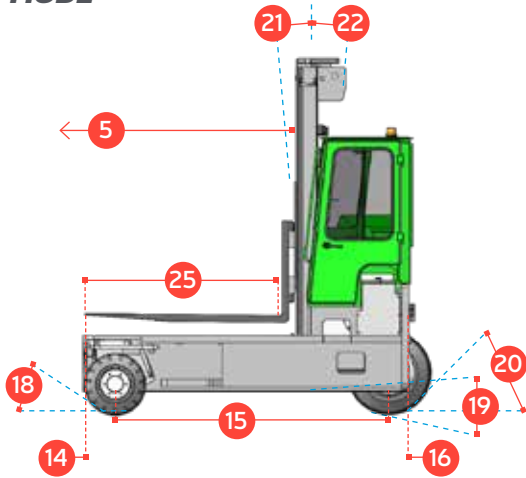

### SIeward MODE

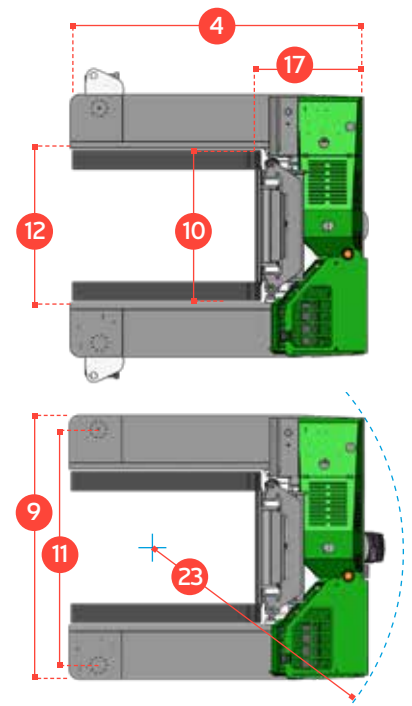
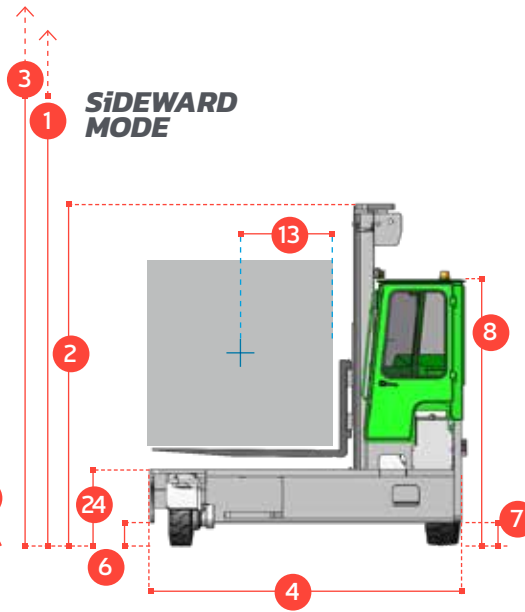

REF.	DESCRIPTION	C6000	C8000
1a	Standard Lift Height	4536 mm	
1b	Free Lift Height	0mm	
2	Height Mast Closed	3430mm	
3	Max. (Mast Raised)	5936mm	
4	Overall Length	2430mm	2670mm
5	Mast Travel	1290mm	1530mm
6	Ground Clearance Under Mast	290mm	
7	Ground Clearance to Wheelbase Centre	165mm	
8	Height Over Cab or of Overhead Guard	2590mm	
9	Width	2800mm	
10	Outside Spread of Fork Arms	1600mm	
11	Track Front	2500mm	
12	Frame Opening	1650mm	
13	Load Centre Distance	600mm	
14	Overhang Front	307mm	
15	Wheel Base	1915mm	2155mm
16	Overhang Back	208 mm	
17	Length from Face of Fork	1180mm	
18	Approach Angle	45°	
19	Ramp Angle	29°	
20	Departure Angle	45°	
21	Forward Tilt	3°	
22	Backward Tilt	5°	
23	Minimum Outside Radius	2540 mm	2765 mm
24	Platform Height	750mm	
25	Platform Length	1250mm	1490mm

### Multi-Directional



### Features Include:

- Rubber Mounted Half Open Cabin
- Multi-Direction Operation
- 3 Wheel Hydrostatic Drive
- Load Sensing Steering
- 4 Way Lever Positioning of Wheels
- Hydraulic Oil Cooler

### Distributed by:

A	Capacity	6000 kg	8000 kg
B	Unladen Weight	10,430 kg	10,950 kg
C	Maximum Ground Speed	15 km/h	
D	Gradeability	15%	
E	Kubota V3800 - TE Diesel / 4.3ltr GM LPG	74 kW/ 72 kW	
F	Electrics	12 Volt	
G	Fork Sections 50mm x 200mm	1250mm	1490mm
H	23 x 10 - 12 Front Tyre	OD580mm / Width 240mm	
I	400 / 60 - 15 Rear Tyre	OD 825mm / Width 326mm	
J	Standard Colour	Green and Grey	
K	Suspension Seat	KAB Model 211	

European Patent No. 2167416; Brazilian Patent No. P10811954-6; Australian Patent No. 2008253242

COMBILIFT HAS A POLICY OF CONTINUOUS PRODUCT DEVELOPMENT AND RESERVES THE RIGHT TO ALTER SPECIFICATIONS WITHOUT PRIOR NOTICE. SPECIFICATIONS AND/OR DIMENSIONS MAY VARY FROM THOSE ILLUSTRATED IN SOME COUNTRIES.